

□

Phys 301 Modern Physics

Class 4: Length Contraction, Lorentz Transformations

What we found so far:

Simultaneity of two events depends on the choice of the reference frame.

Lucy: in the train

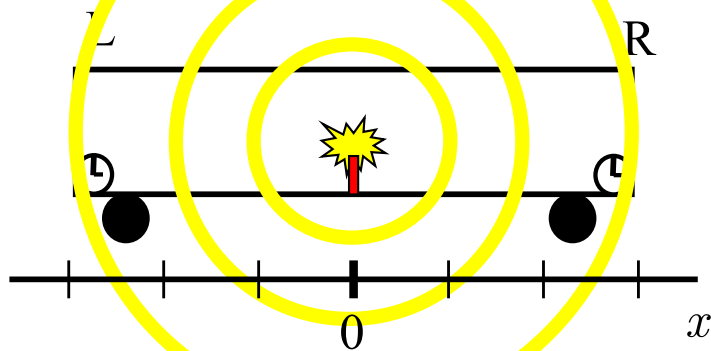

Event L:
($x = -3, t = 3\text{s}$)

Event R:
($x = +3, t = 3\text{s}$)

Ricky: on the platform

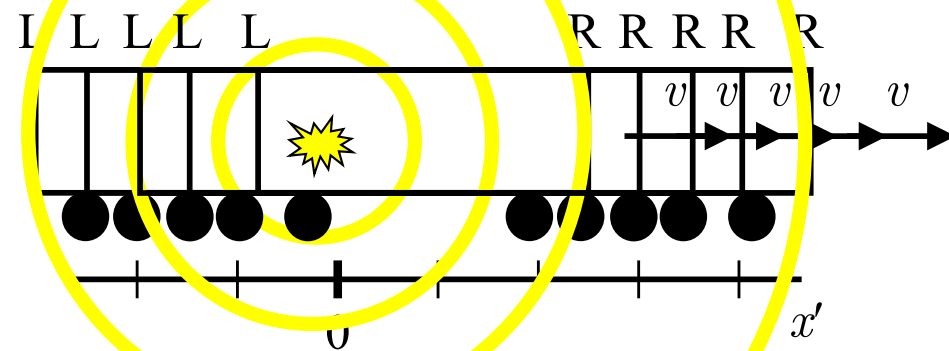

Event L':
($x' = -2, t' = 2\text{s}$)

Event R':
($x' = +5, t' = 4\text{s}$)

Lucy says: 'Simultaneous!' Ricky says: 'Not simultaneous'

What we found so far:

Time Dilation: Two observers (moving relative to each other) can measure different durations between two events.

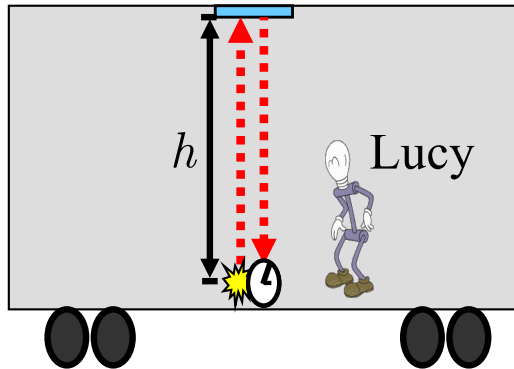

Lucy measures:

$$\Delta\tau = 2h/c$$

Here: Lucy measures the **proper time**.

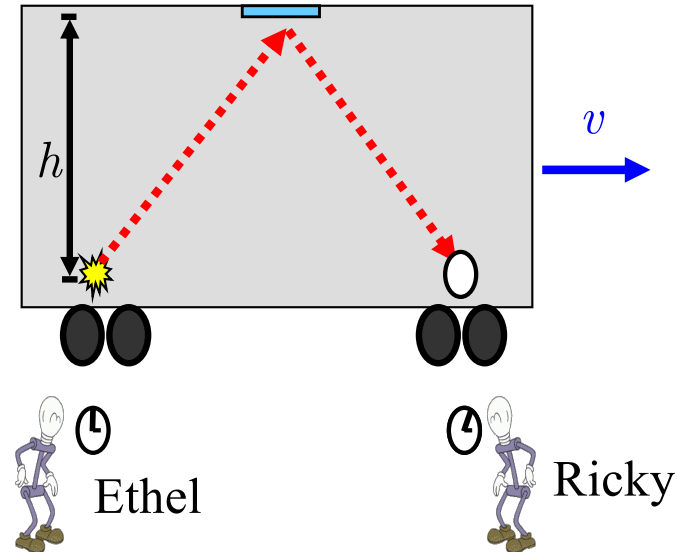

Ethel and Ricky:

$$\Delta t = \gamma \Delta\tau$$

Measurable Properties

- Time
 - “Proper Time” between 2 events
 - ONE inertial ref. frame
 - All other frames measure different time.
- Length (diff. btwn two positions)
 - “Proper Length”???

Length of an object

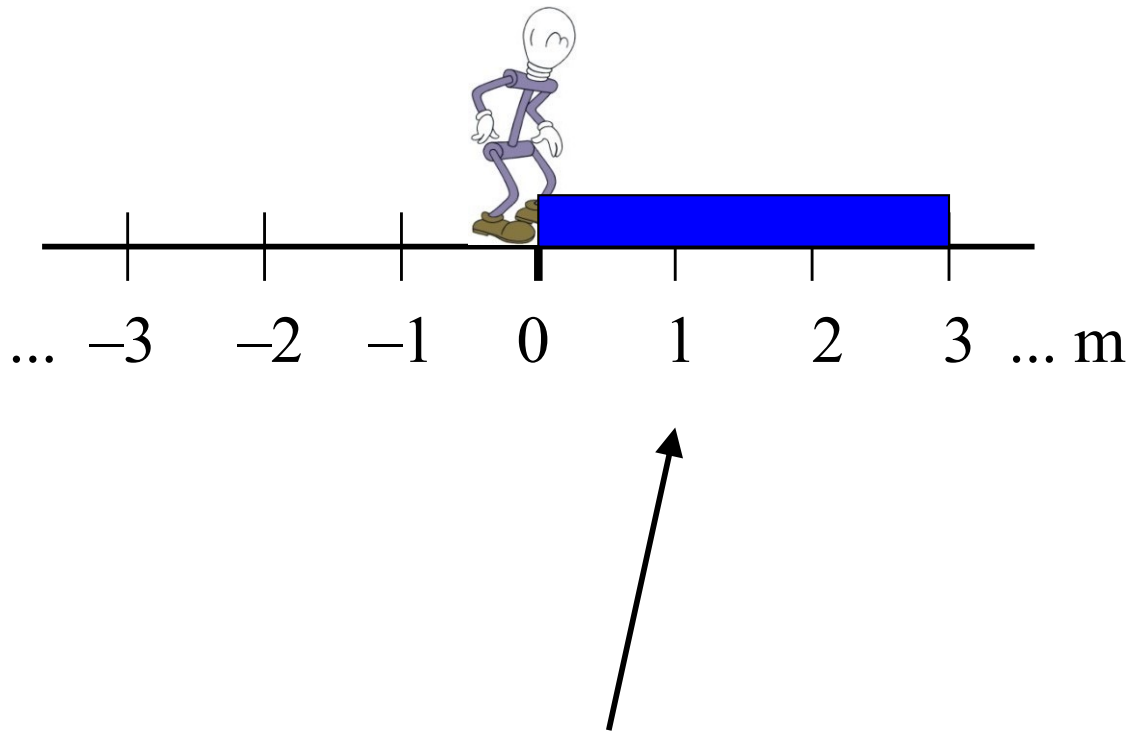

- 3 m long.
- Measure both ends at *same time*.

Length measured in the stick's rest frame is its **proper length**.

Remember ‘proper time’

Proper time: Time interval between two events measured in the frame where the two events occur at the same spatial coordinate.

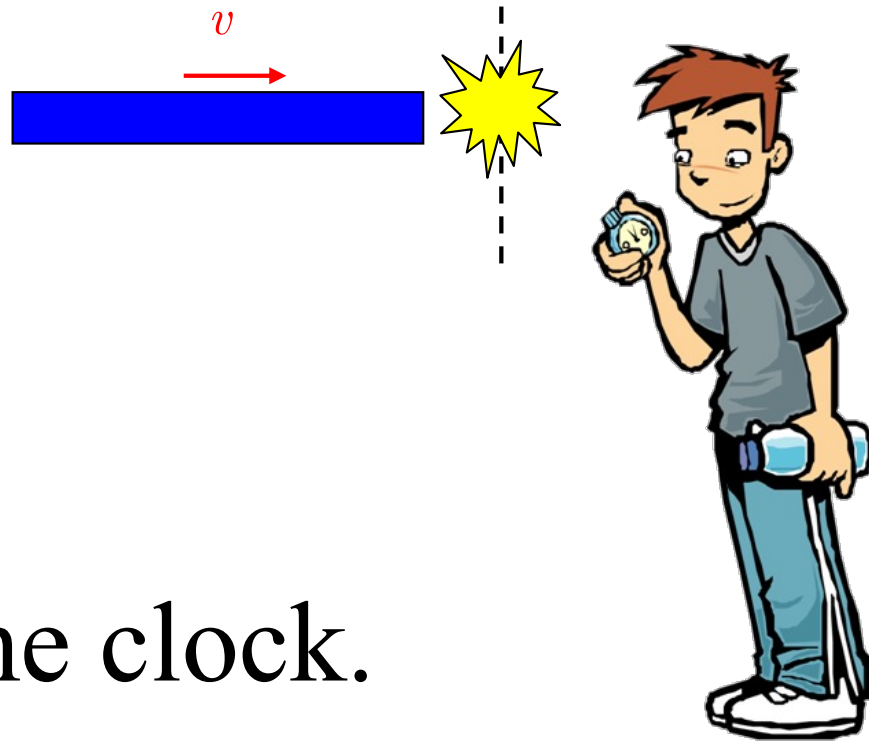

$$\Delta\tau = t_2 - t_1$$

Measured with one clock.

How does moving observer measure length?

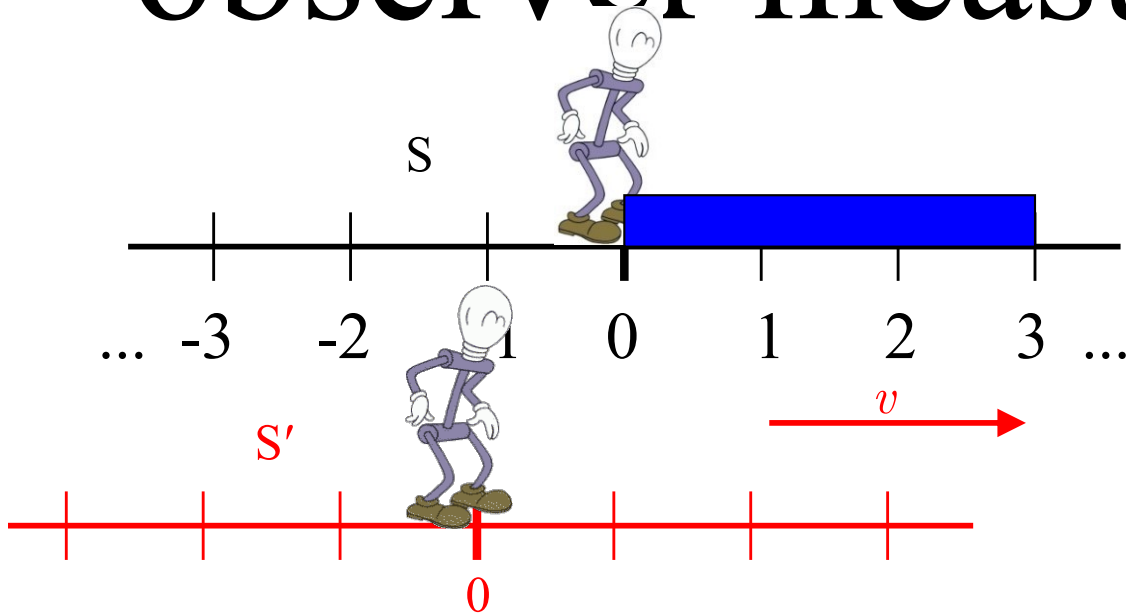

Event 1 – Origin of S' passes left end of stick.

Event 2 – Origin of S' passes right end of stick.

Two Questions

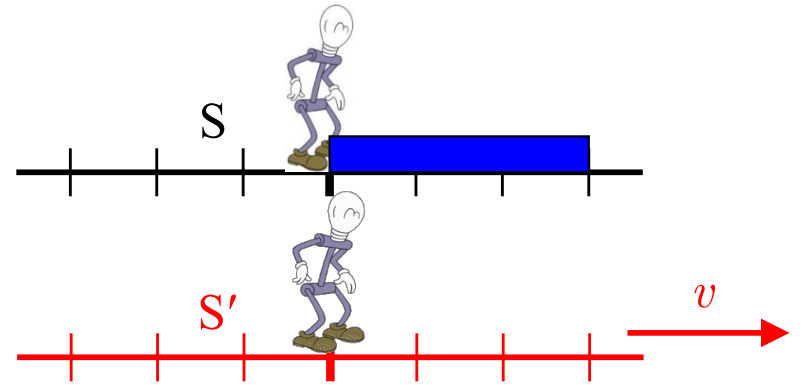

- Who is measuring proper length?
S, S' , or neither?
- Who is measuring proper time?
S, S' , or neither?

Summarize Measurements

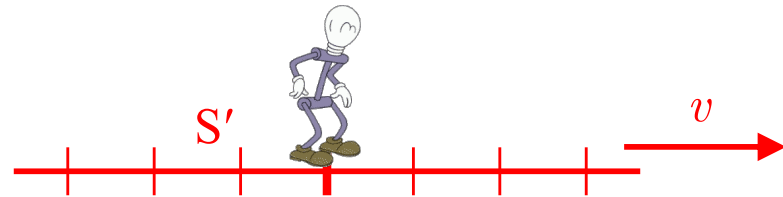
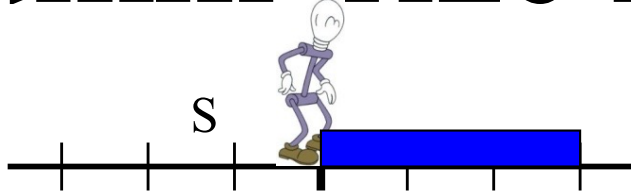

$$\Delta x = L$$

Proper Length

$$\Delta t = \gamma \Delta \tau$$

Because Time Dilation

$$|v| = \frac{L}{\gamma \Delta \tau}$$

Speed of S' rel. to S

$$\Delta x' = L'$$

Thing We Want To Find

$$\Delta t' = \Delta \tau$$

Proper Time

$$|v| = \frac{L'}{\Delta \tau}$$

Speed of S rel. to S'

Group Activity

- Combine equations, solve for L' in terms of L . $L' = L/\gamma$
- What is minimum value of γ ? $\gamma = 1$
 $v = 0$
- What is maximum/approaching value of γ ? $\gamma \rightarrow \infty, v \rightarrow \infty$
- Is L' always greater than L , always less than L , or does it depend on something? If so, what? $L' \leq L$

Length Contraction

$$L' = \frac{L}{\gamma}$$

Length in
moving frame

Length in stick's
rest frame
(proper length)

Length contraction is a consequence of time dilation (and vice-versa).

Example Problem: Length Contraction

You board a spacecraft and travel at $0.9c$. You are cryogenically frozen; you are lying down in the direction of motion of the spacecraft away from Earth. You were 6 feet tall on Earth. How tall would you appear in the Earth's reference frame?

$$L = 6 \text{ ft} \quad \gamma = \frac{1}{\sqrt{1 - \left(\frac{v}{c}\right)^2}}$$
$$v = 0.9c$$

$$L' = \frac{L}{\gamma}$$

$$= L \sqrt{1 - \left(\frac{v}{c}\right)^2}$$
$$= (6 \text{ ft}) \sqrt{1 - (0.9)^2}$$

$$= 2.6 \text{ ft}$$

Handout

INVARIANT QUANTITIES

The Lorentz transformation

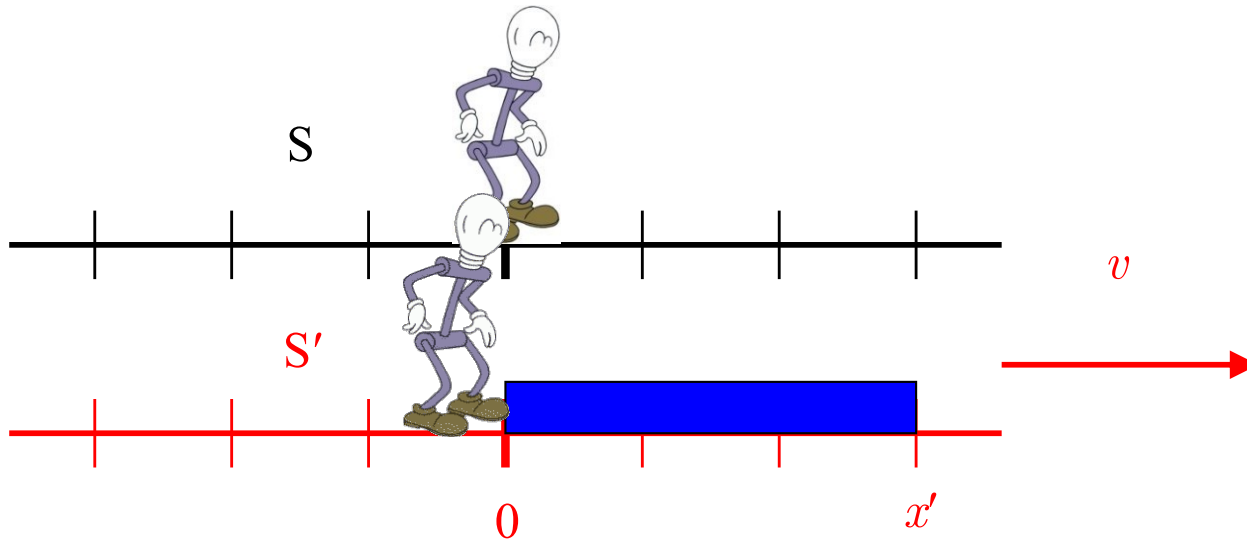

Event 1 – left of stick passes origin of S. Its coordinates are $(0,0)$ in S and $(0,0)$ in S'.

A stick is at rest in S'. Its endpoints are the events $(x,t) = (0,0)$ and $(x',0)$ in S'. S' is moving to the right with respect to frame S.

Lorentz transformation

An observer at rest in frame S sees a stick flying past him with velocity v :

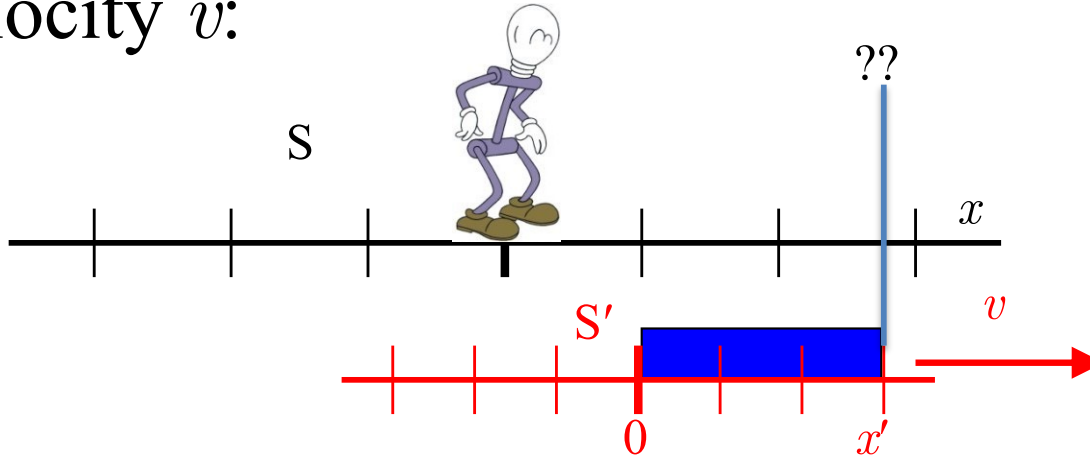

As viewed from S, the stick's length is x'/γ . Time t passes. According to S, where is the *right* end of the stick? (Assume the *left* end of the stick was at the origin of S at time $t = 0$.)

- A) $x = \gamma vt$ B) $x = vt + x'/\gamma$ C) $x = -vt + x'/\gamma$
D) $x = vt - x'/\gamma$ E) Something else ...

The Lorentz transformation

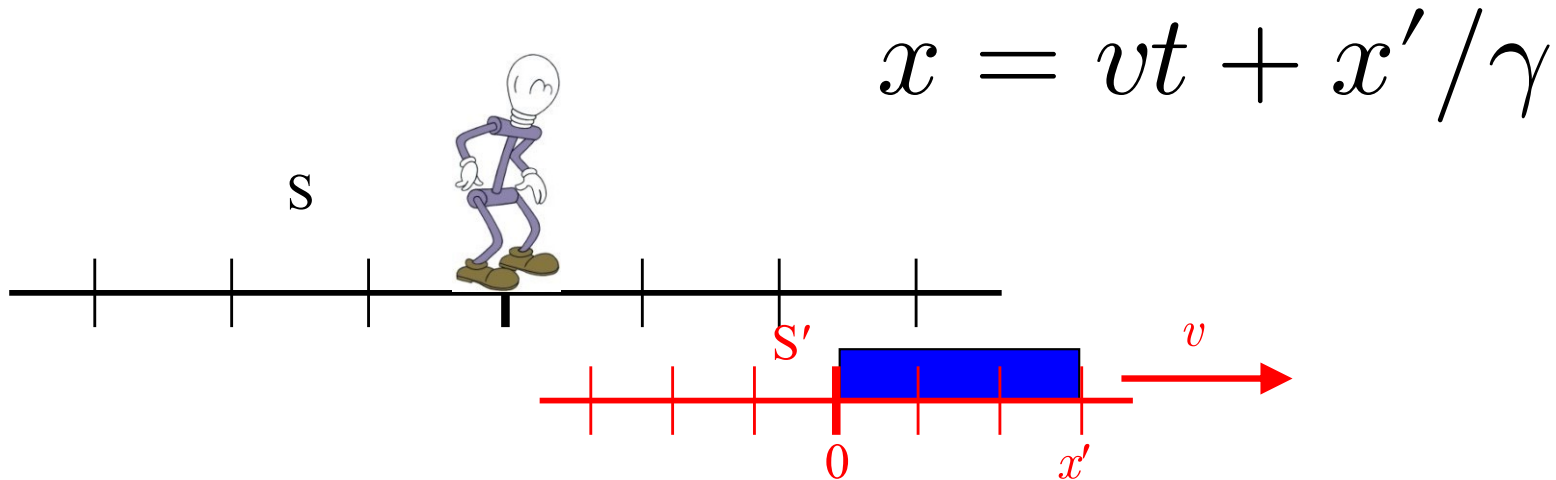

This relates the spatial coordinates of an event in one frame to its coordinates in the other.

Rearrange to solve for x' as function of x .

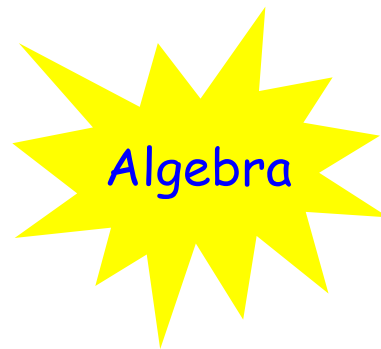

$$x' = \gamma(x - vt)$$

Transformations

If S' is moving with speed v in the positive x direction relative to S , then the coordinates of the same event in the two frames are related by:

Galilean transformation
(classical)

$$x' = x - vt$$

$$y' = y$$

$$z' = z$$

$$t' = t$$

Lorentz transformation
(relativistic)

$$x' = \gamma(x - vt)$$

$$y' = y$$

$$z' = z$$

$$t' = \gamma \left(t - \frac{v}{c^2} x \right)$$

Note: This assumes $(0,0,0,0)$ is the same event in both frames.

Binomial Approximation $\gamma = \frac{1}{\sqrt{1 - \left(\frac{v}{c}\right)^2}}$

- If $x \ll 1$, then $(1 + x)^n \approx 1 + nx$
- What is an approximation of γ when $v \ll c$?

$$\gamma = \left(1 - \left(\frac{v}{c}\right)^2\right)^{-\frac{1}{2}} \approx 1 + \frac{1}{2} \left(\frac{v}{c}\right)^2$$

- What is an approximation of $1/\gamma$ when $v \ll c$?

$$\gamma = \left(1 - \left(\frac{v}{c}\right)^2\right)^{+\frac{1}{2}} \approx 1 - \frac{1}{2} \left(\frac{v}{c}\right)^2$$

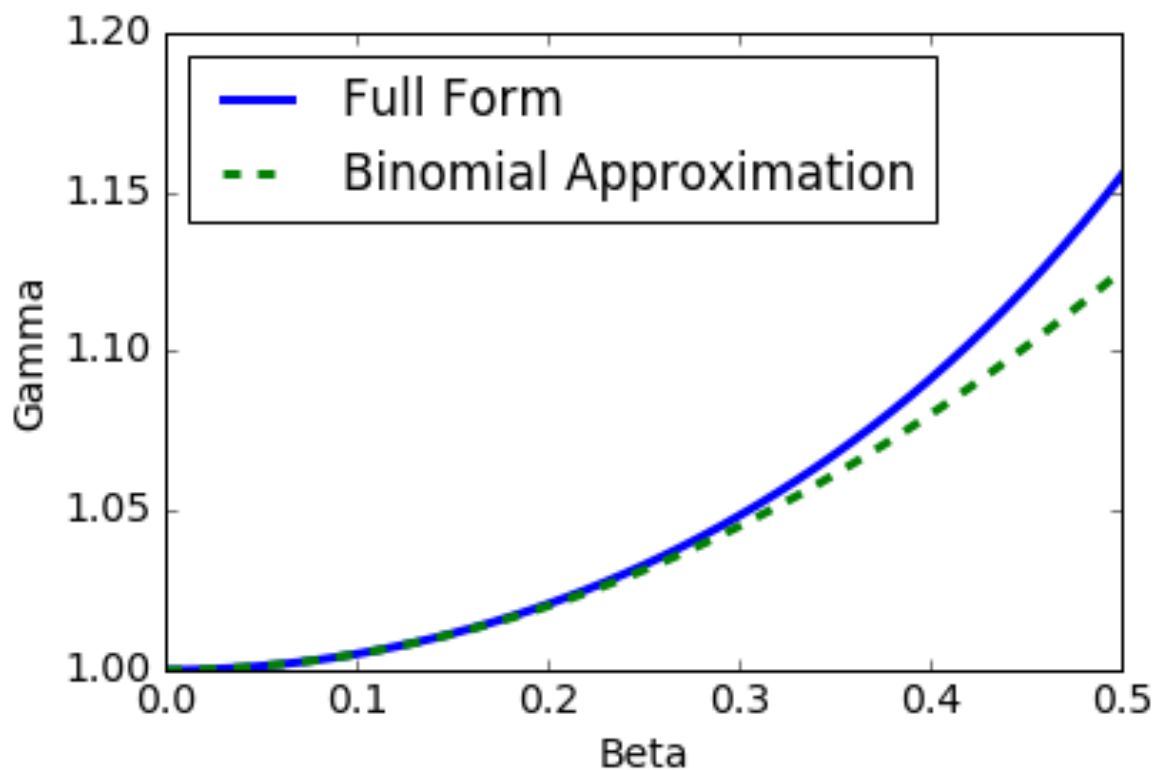
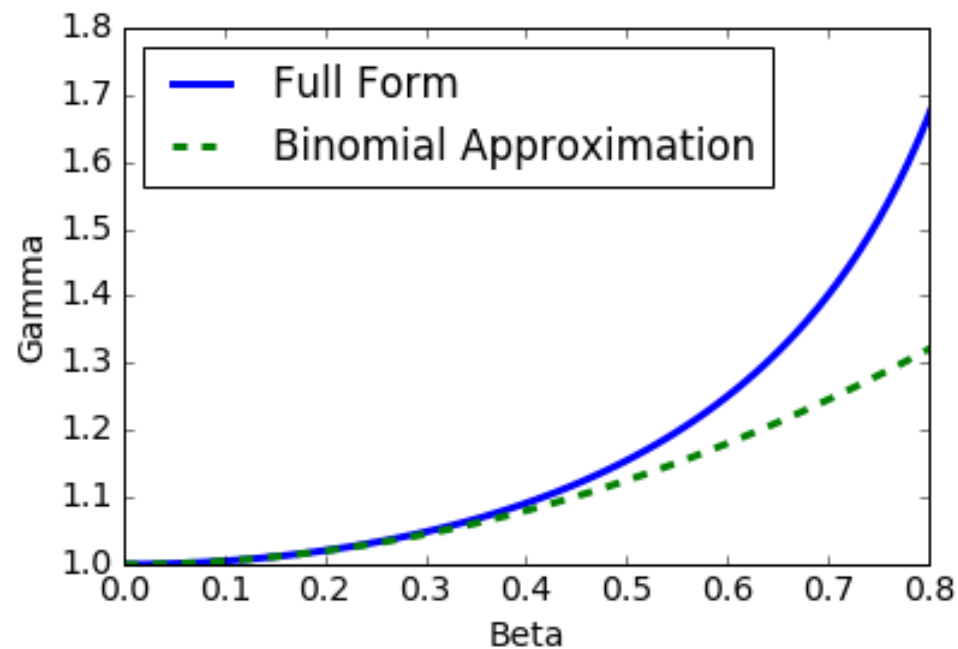
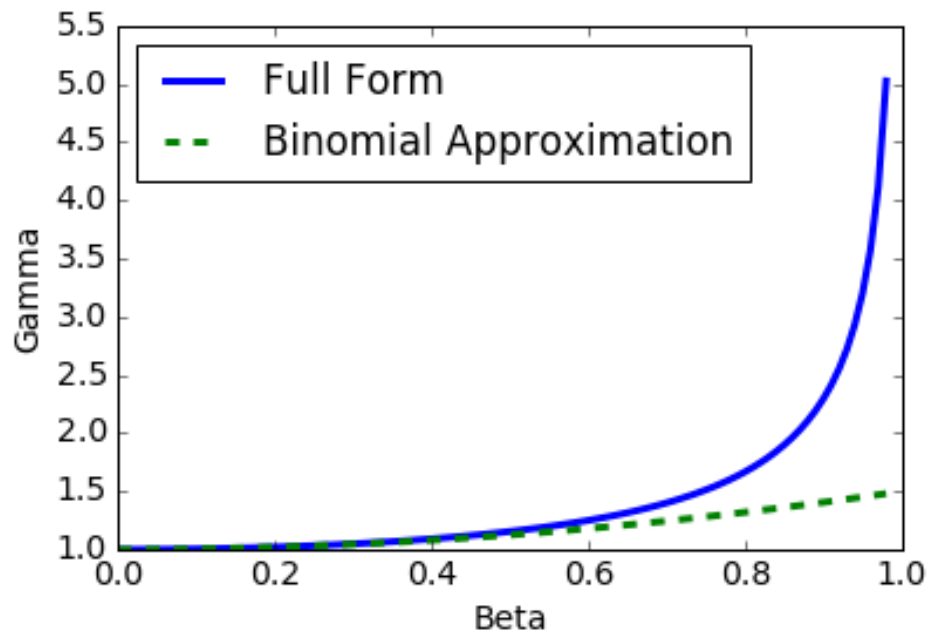

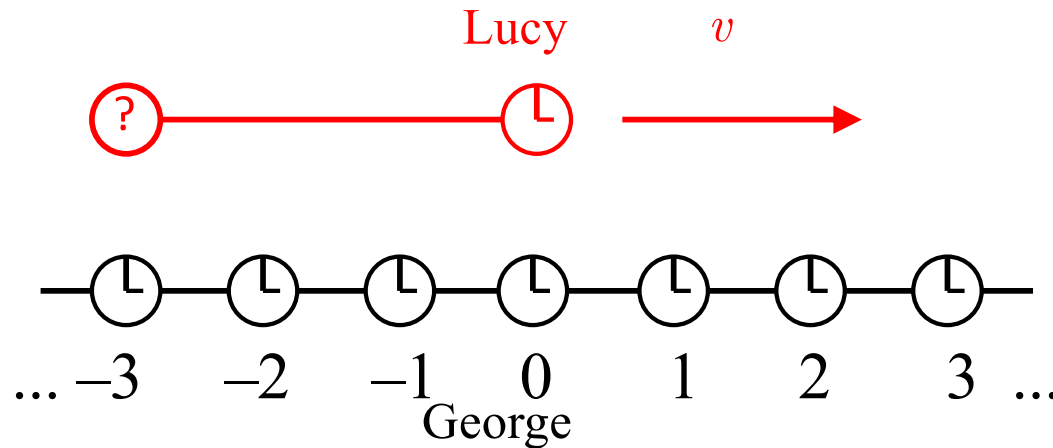

$$x' = \gamma(x - vt)$$

$$t' = \gamma\left(t - \frac{v}{c^2}x\right)$$

George has a set of synchronized clocks in reference frame S, as shown. Lucy is moving to the right past George and has (naturally) her own set of synchronized clocks. Lucy passes George at the event (0 m, 0 s) in both frames. An observer in George's frame checks the clock marked '?'. Compared to George's clocks, this one reads

- A) a slightly earlier time
- B) a slightly later time
- C) same time

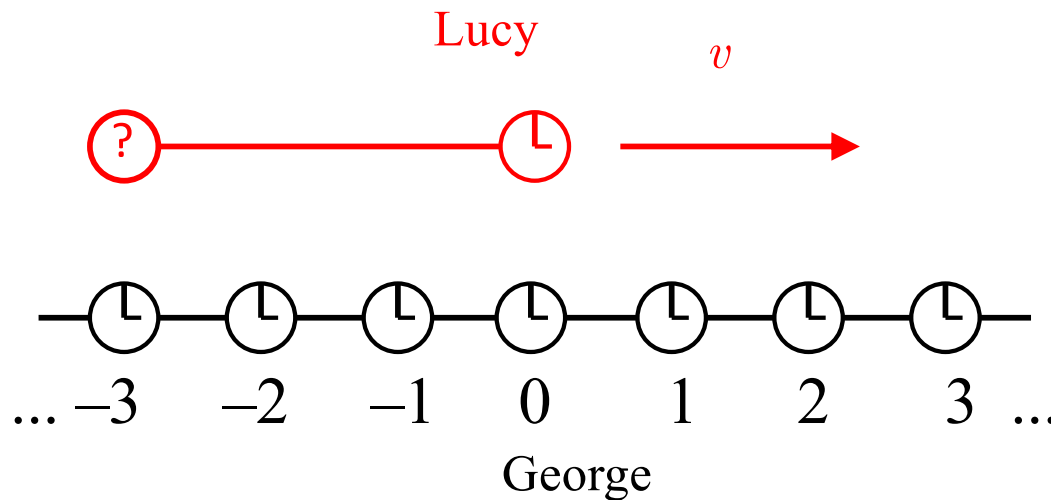

$$x' = \gamma(x - vt)$$

$$t' = \gamma\left(t - \frac{v}{c^2}x\right)$$

The event has coordinates $(x = -3\text{m}, t = 0\text{s})$ for George.
 In Lucy's frame, where the ? clock is, the time t' is

$$t' = \gamma\left(0 - \frac{v}{c^2}(-3\text{m})\right) = (+3\text{m})\frac{\gamma v}{c^2}, \text{ a positive quantity.}$$

B) a slightly later time

Lorentz Velocity Transformations

Frame S' moves relative to S .

An object is moving through both frames at velocity u and u' , respectively.

$$\begin{aligned}x' &= \gamma(x - vt) \\t' &= \gamma\left(t - \frac{v}{c^2}x\right)\end{aligned}$$

$$u' = dx'/dt'$$

Use expressions for dx' and dt' , take derivative to find u' in terms of u , v , c .

Lorentz Velocity Transformations

$$u' = \frac{u - v}{1 - uv/c^2}$$

$$u = \frac{u' + v}{1 + u'v/c^2}$$

Must distinguish v , u , and u' !

Example Problem

A rocket flies past earth at $0.800c$. It fires a bullet in the forward direction at $0.950c$ with respect to the rocket. What is the bullet's speed with respect to the Earth?

What would Galilean relativity say?

What if the bullet were instead a beam of light?

What if the bullet was fired the opposite direction?